

December 30, 2003

Refer to: HSA-10/WZ-141

Mr. Grant Dicke  
Dicke Tool/INCOM, Incorporated  
1201 Warren Avenue  
Downers Grove, Illinois 60515

Dear Mr. Dicke:

This is in response to your requests for Federal Highway Administration (FHWA) acceptance of your company's portable sign stands as crashworthy traffic control devices for use in work zones on the National Highway System (NHS). The dates and subjects of the requests are as follows:

- 1) November 21, 2002 TF60 Stand, breakaway, with rigid, semi rigid, and flexible signs
- 2) December 4, 2002 TF84, TF84-7 stands with rollup signs, different leg lengths
- 3) December 5, 2002 TF12C, TF12W, UF2000C Compact Stands with roll up signs
- 4) January 14, 2003 TF12C, TF12W, additional information provided
- 5) July 18, 2003 TF12C with RUR44FFS2 Roll Up sign panel
- 6) November 19, 2003 UF 2000S and 2000C with Roll Up sign panel
- 7) November 19, 2003 TF18 Stand with rigid, semi rigid, and flexible signs
- 8) December 9, 2003 Backup info for TF 18 stand, plus TF 84 with Endurance and Alpolic

You included detailed drawings of each stand, a discussion of full scale and/or bogie vehicle testing conducted on similar stands by you and others, and comments on the appropriate signs for each stand. You requested that we find these devices acceptable for use on the NHS under the provisions of National Cooperative Highway Research Program (NCHRP) Report 350 "Recommended Procedures for the Safety Performance Evaluation of Highway Features."

### **Introduction**

The FHWA guidance on crash testing of work zone traffic control devices is contained in two memoranda. The first, dated July 25, 1997, titled "INFORMATION: Identifying Acceptable Highway Safety Features," established four categories of work zone devices: Category I devices are those lightweight devices which are to be self-certified by the vendor, Category II devices are other lightweight devices which need individual crash testing but with reduced instrumentation, Category III devices are barriers and other fixed or heavy devices also needing crash testing with normal instrumentation, and Category IV devices are trailer mounted lighted signs, arrow panels, etc. for which

crash testing requirements have not yet been established. The second guidance memorandum was issued on August 28, 1998, and is titled “INFORMATION: Crash Tested Work Zone Traffic Control Devices.” This later memorandum lists devices that are acceptable under Categories I, II, and III.

A brief description of the devices in each request follows:

- 1) November 21, 2002 TF60 Stand, breakaway, with rigid, semi rigid, and flexible signs

The TF60 Stand shares the same base you tested with rollup signs (stands designated as DF4503 and covered in FHWA acceptance letter WZ-99). You have successfully tested this breakaway concept at the Midwest Roadside Safety Facility (MwRSF) using a rollup sign at a height of 60 inches. Your request is to use this hardware to support rigid, semi rigid, and flexible signs at a height of 60 inches.

	Comparison Stand	Subject Stand
Test Number	D-29	Not Tested
Sign Stand Tested	DF4503	TF-60
Weight of Tested Stand	45 Lbs	
Mounting height	60 inches	60 inches
Flags? Lights?	3 Flags	3 Flags, or 2 Flags & Light
Impact Speed	107.5 km/hr	n/a
Velocity Change	0.89 m/s (3.2 ft/s)	n/a
Extent of contact	Minor, on bumper & roof	n/a

During the test DF4503 sign and mast rotated over the vehicle with no potential to contact the windshield. In addition, bogie testing with plywood and aluminum signs (DB 83-87) showed that the breakaway base activated upon impact and the sign did not contact the “vehicle” at the windshield, although contact with the roof would occur. Because the rigid and semi-rigid signs on the TF-60 will be of a greater mass and will raise the center of gravity of the signs, rigid and semi rigid substrates may be used, with or without flags/lights. Signs of these substrates are also likely to stay above the vehicle as they begin to rotate immediate after the impact that activates the breakaway feature. The drilled holes breakaway feature of the TF-60 sign stand is critical, especially for use with the rigid and semi rigid substrates.

- 2) December 4, 2002 TF84, TF84-7 stands with rollup and rigid signs, and different leg lengths.

The TF84 stands are designed for use with rollup signs, and are similar to the TF60 Breakaway stand. Each stand consists of a two stage telescoping mast, 1.5 inch square aluminum and 1.25 inch square aluminum with 0.100 inch walls. The mast is supported by a heavy duty dual upright spring system. The TF84 has 84 inch long, 1.25 inch square aluminum legs, while the legs on the TF84-7 stand are 72 inches long. As the breakaway function of this stand will be identical to that of the TF60 stand, and the top of the stand will be 14 inches higher, it will be acceptable for use with rollup signs as requested. Your letter of December 9, 2003, requested the acceptance be for rollup

and rigid signs, including 0.080 and 0.125 aluminum, 10 mm Endurance, and Alpollic substrates. As the TF84 is a taller stand and the additional weight of the solid substrates will raise the center of gravity of the system, it can be expected that the breakaway performance will be enhanced due to the greater height over the vehicle achieved by the stand and sign components. Therefore, the requested substrates will also be acceptable for use as noted.

- 3) December 5, 2002 TF12C, TF12W, UF2000C Compact Stands with roll up signs  
 4) January 14, 2003 TF12C, TF12W, additional information provided

These three “compact” stands consist of single or dual upright springs supporting a short mast. The mast holds the vertical fiberglass rib of a 48 x 48 rollup sign. Your rollup signs use 3/8 inch thick vertical masts and 1/4 inch thick horizontal spreaders. These dimensions are 1/16 inch thicker than those we consider universally acceptable for rollup signs, but your prior crash testing indicates that these signs will perform in an acceptable manner. Bogie testing (DB101, DB102) illustrates the successful performance of the TF12C stand. In these tests, although the sign and/or flags impact at the bottom of the windshield, there are no hard elements involved that could pose a serious threat to the vehicle occupants. The universal sign clamp which is a feature of the TF12W stand, was shown to perform acceptably in FHWA WZ-25.

- 5) July 18, 2003 TF12C with RUR48FFS2 Roll Up sign panel

This compact stand with dual upright springs was bogie tested with a roll up sign. The same roll-up sign was crash tested earlier using a different Dicke Tool stand with successful results. You requested that this sign be acceptable for use with other stands similar to the TF12C.

Test Number	DB-101	DB-102
Sign Stand Tested	TF12C	TF12C
Weight of Tested Stand	23 pounds	23 pounds
Mounting heights	12 inches	12 inches
Flags? Lights?	none	none
Mass of Test Vehicle	820 kg	
Impact Speed	96.8 k/hr (60.1 mph)	96.1 km/h (59.7 mph)
Velocity Change	0.30 m/s	0.83 m/s
Extent of contact	Minimal	Minimal

The bogie tests also show acceptable performance.

- 6) November 19, 2003 UF 2000S and 2000C with Roll Up sign panel

The UF2000S stand features a single upright vertical spring with a “stablock” sign attachment as used in a variety of stands with a variety of spring configurations. The FHWA WZ-17 accepted the stablock feature on a dual upright spring stand, model number DF 3000S. The UF2000C stand consists of a single upright vertical spring with an aluminum channel mounted vertically to display a rollup sign at a 12 inch mounting

height. DB101 and DB102 illustrate the favorable results with the aluminum channel sign attachment, while D18-2 and D23-2 illustrate the favorable results with the UF2000 at 0 and 90 degrees with a clamping mechanism shared by other stands.

7) November 19, 2003 and

8) December 9, 2003 TF18 Breakaway Stand with rigid, semi rigid, and flexible signs

Rigid signs mounted on portable stands at the range of 12 to 18 inches have a great potential to cause severe windshield damage. Your request is to compare your TF18 to the breakaway portable sign crash tested by another manufacturer, using a bogie test of your stand to verify that the breakaway mechanism functions as designed. Testing of rigid substrates at this height, even with breakaway features, has yielded marginal results. Subsequently you provided information on a full-scale crash test with your similar DF 4000 stand supporting an 0.080 aluminum sign. The test was deemed a failure, but improvements you made to the stand and its breakaway feature that were verified with bogie testing at zero and 90 degrees show that the stand would pass with the aluminum substrate mounted at 18 inches. You also requested the use of 0.125 aluminum signs with this stand. Comparison of full-scale and bogie tests shows that the impact to the windshield area would be comparable to that of the 0.080 substrate. Therefore, we concur in your request to use signs of rollup material, 0.080 and 0.125 aluminum, Endurance, and Alpolic with the TF18 breakaway stand.

### **Testing**

Your requests are based on a combination of full-scale crash tests conducted on similar versions of your company's stands, on similarity to other manufacturer's stands, and on bogie vehicle testing of the exact sign and stand combinations in question. This crash-testing program used a hard-nosed bogie vehicle of a mass larger than the standard 820C test vehicle. There are significant constraints involved in using such a non-standard testing device, some of which are:

1. The potential vehicle velocity change must be considered insignificant.
2. The crush characteristics of an automobile bumper must not be expected to have a significant affect on the trajectory of the test article.
3. The profile of the bogie vehicle must be configured to replicate the outline of a production vehicle. The MwRSF bogie was configured to replicate the outline of a Geo Metro, a vehicle commonly used in testing of work zone devices.
4. No part of the test article may intrude into the windshield area of the vehicle after impact.

For bogie testing that supports requests 1 through 6, we concur that your testing has shown acceptable performance. Subsequent discussions on Request 7 concerning the rigid signs on the TF-18 stand led to your submission of additional information in Request 8 using full-scale and bogie testing to justify the use of the rigid signs.

## Findings

The results of the testing of the stands and signs summarized here met FHWA requirements:

- 1) TF60 Stand, breakaway, with rigid, semi rigid, and flexible signs  
 Non-reflective vinyl, Superbrite, RS34, Marathon, RS24  
 Intepro Plastic 10mm and 12mm, Endurance 10mm and 16mm  
 Alpolic 2mm and 3mm, ABS 3mm, 4.7mm, and 6.2mm  
 Aluminum 2mm, 2.2mm, 2.5mm, 3mm  
 Plywood 9.4mm, 12.5mm, 15.6mm, 18.8mm
- 2) TF84, TF84-7 stands with 48 x 48 rollup signs, different leg lengths  
 Non reflective vinyl, Superbrite, RS34, Marathon, RS24, also 0.080 and 0.125  
 aluminum, 10 mm Endurance and Alpolic
- 3) & 4) TF12C, TF12W, UF2000C Compact Stands with roll up signs  
 Non reflective vinyl, Superbrite, RS34, Marathon, RS24
- 5) TF12C with RUR44FFS2 Roll Up sign panel  
 Non reflective vinyl, Superbrite, RS34, Marathon, RS24
- 6) UF 2000S and 2000C with Roll Up sign panel  
 Non reflective vinyl, Superbrite, RS34, Marathon, RS24
- 7) & 8) TF18 Breakaway Stand with rigid, semi rigid, and flexible signs  
 Non reflective vinyl, Superbrite, RS34, Marathon, RS24, also 0.080 and 0.125  
 aluminum, 10 mm Endurance and Alpolic

Therefore, the devices listed above and detailed in the enclosed drawings are acceptable for use on the NHS under the range of conditions tested, when proposed by a State.

Please note the following standard provisions that apply to FHWA letters of acceptance:

- Our acceptance is limited to the crashworthiness characteristics of the devices and does not cover their structural features, or conformity with the Manual on Uniform Traffic Control Devices.
- Any changes that may adversely influence the crashworthiness of the device will require a new acceptance letter.
- Should FHWA discover that the qualification testing was flawed, that in-service performance reveals unacceptable safety problems, or that the device being marketed is significantly different from the version that was crash tested, it reserves the right to modify or revoke its acceptance.
- You will be expected to supply potential users with sufficient information on design and installation requirements to ensure proper performance.
- You will be expected to certify to potential users that the hardware furnished has essentially the same chemistry, mechanical properties, and geometry as that submitted for acceptance, and that they will meet the crashworthiness requirements of FHWA and NCHRP Report 350.

- To prevent misunderstanding by others, this letter of acceptance, designated as number WZ-141 shall not be reproduced except in full. This letter, and the test documentation upon which this letter is based, is public information. All such letters and documentation may be reviewed at our office upon request.
- Dicke Tool signs may include patented components and if so are considered "proprietary." The use of proprietary work zone traffic control devices in Federal-aid projects is generally of a temporary nature. They are *selected by the contractor* for use as needed and removed upon completion of the project. Under such conditions they can be presumed to meet requirement "a" given below for the use of proprietary products on Federal-aid projects. On the other hand, if proprietary devices are *specified by a highway agency* for use on Federal-aid projects they: (a) must be supplied through competitive bidding with equally suitable unpatented items; (b) the highway agency must certify that they are essential for synchronization with existing highway facilities or that no equally suitable alternative exists or; (c) they must be used for research or for a distinctive type of construction on relatively short sections of road for experimental purposes. These provisions do not apply to exempt non-NHS projects. Our regulations concerning proprietary products are contained in Title 23, Code of Federal Regulations, Section 635.411, a copy of which is enclosed.
- This acceptance letter shall not be construed as authorization or consent by FHWA to use, manufacture, or sell any patented device. Patent issues are to be resolved by the applicant and the patent owner.

Sincerely yours,

*/Original signed by/*

John R. Baxter, P.E.  
 Director, Office of Safety Design  
 Office of Safety

Enclosure

FHWA:HSA-10:NArtimovich:tb:x61331:12/22/03

File: h://directory folder/nartimovich/WZ141-DickeFIN

cc: HSA-10 (Reader, HSA-1; Chron File, HSA-10;  
 N. Artimovich, HSA-10)

Sec. 635.411 Material or product selection.

(a) Federal funds shall not participate, directly or indirectly, in payment for any premium or royalty on any patented or proprietary material, specification, or process specifically set forth in the plans and specifications for a project, unless:

- (1) Such patented or proprietary item is purchased or obtained through competitive bidding with equally suitable unpatented items; or
- (2) The State highway agency certifies either that such patented or proprietary item is essential for synchronization with existing highway facilities, or that no equally suitable alternate exists; or
- (3) Such patented or proprietary item is used for research or for a distinctive type of construction on relatively short sections of road for experimental purposes.

(b) When there is available for purchase more than one nonpatented, nonproprietary material, semifinished or finished article or product that will fulfill the requirements for an item of work of a project and these available materials or products are judged to be of satisfactory quality and equally acceptable on the basis of engineering analysis and the anticipated prices for the related item(s) of work are estimated to be approximately the same, the PS&E for the project shall either contain or include by reference the specifications for each such material or product that is considered acceptable for incorporation in the work. If the State highway agency wishes to substitute some other acceptable material or product for the material or product designated by the successful bidder or bid as the lowest alternate, and such substitution results in an increase in costs, there will not be Federal-aid participation in any increase in costs.

(c) A State highway agency may require a specific material or product when there are other acceptable materials and products, when such specific choice is approved by the Division Administrator as being in the public interest. When the Division Administrator's approval is not obtained, the item will be nonparticipating unless bidding procedures are used that establish the unit price of each acceptable alternative. In this case Federal-aid participation will be based on the lowest price so established.

(d) Appendix A sets forth the FHWA requirements regarding (1) the specification of alternative types of culvert pipe, and (2) the number and types of such alternatives which must be set forth in the specifications for various types of drainage installations.

~~(e) Reference in specifications and on plans to single trade name materials will not be approved on Federal-aid contracts.~~

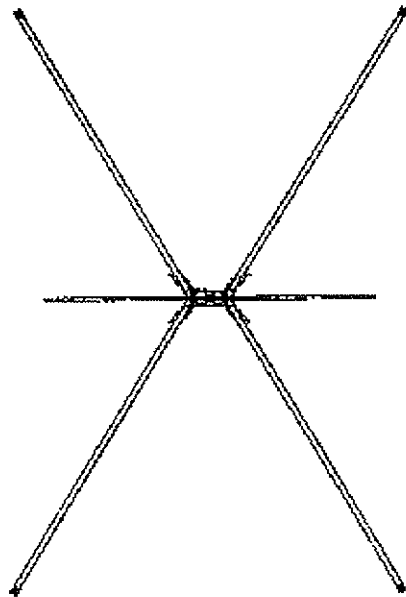
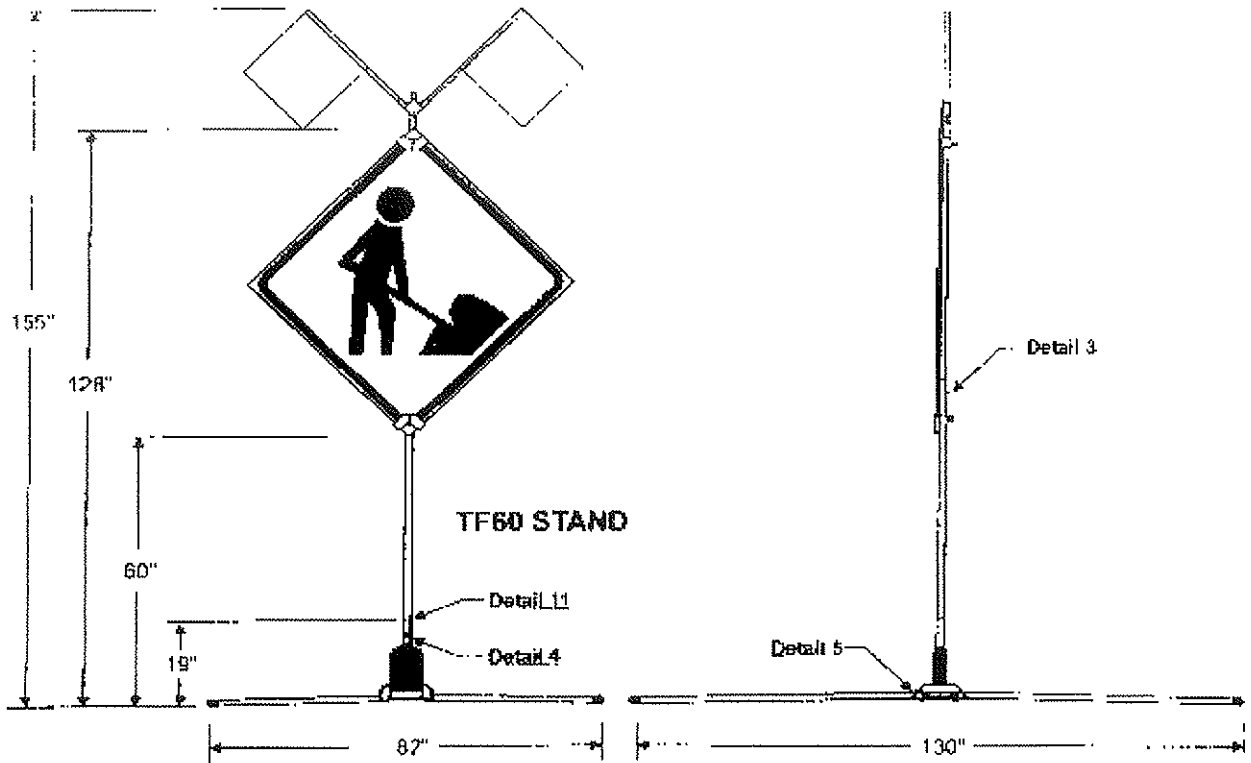

### **TF60 STAND**

- Base- Steel with heavy duty dual spring system (1/2" dia. steel wire).
- Mast- 2 stage telescoping, sq. aluminum tubing with .100 wall thickness
- Legs- Telescoping 1-1/4" sq. x .100 wall x 72" alum. tube, 1" sq. x .100 wall x 25" alum tube
- Panel- Rigid .080 - .125 aluminum or 1/2" - 3/4" plywood, 48" x 48".
- Flags- 18" x 18" vinyl with 30" staff
- Weight (without sign panel) - 45 lbs.



ATTACHMENT METHODS

REF: DETAIL 11 - Break Away Mast

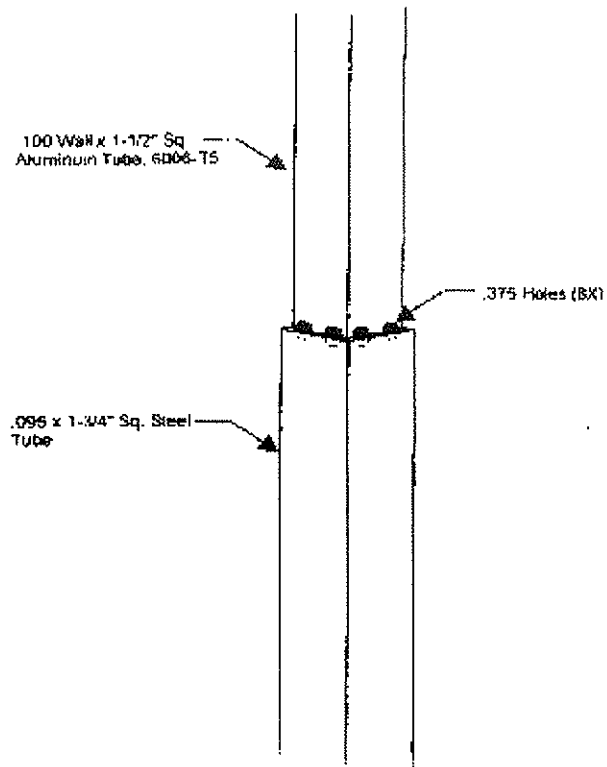

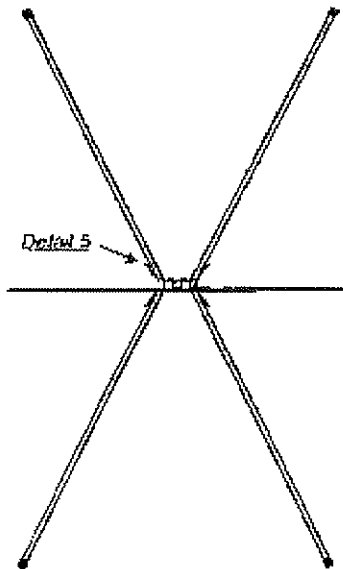
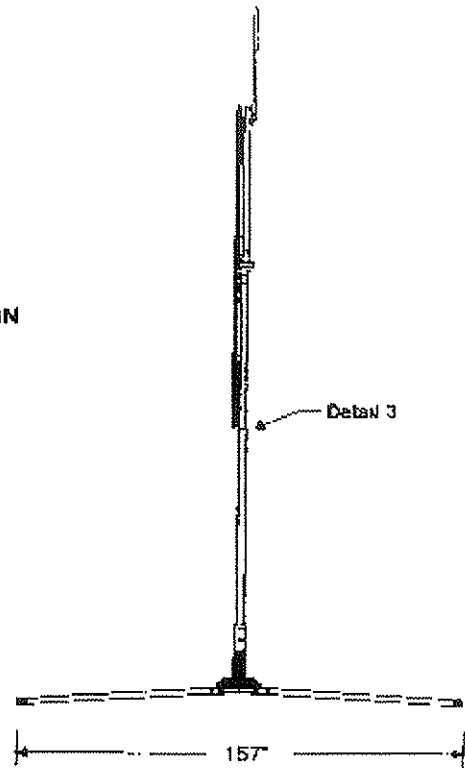
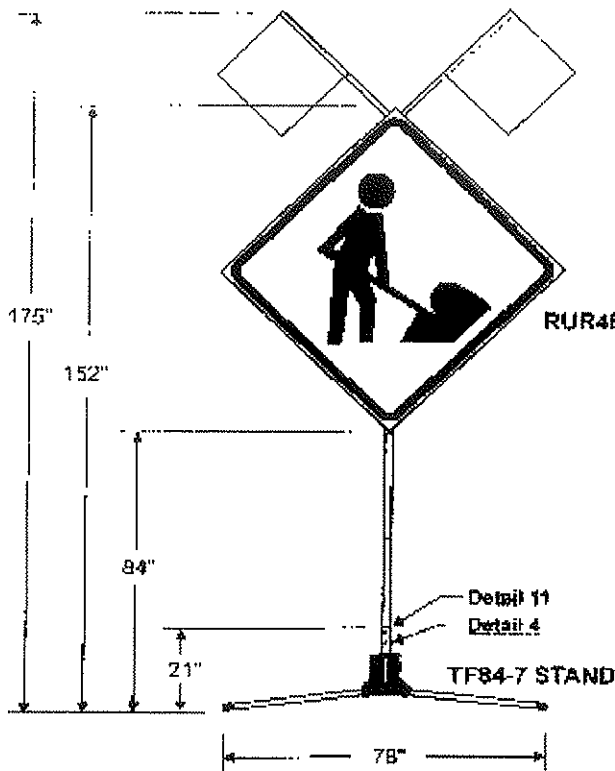

#### **TF84-7 STAND**

- Base- Steel with heavy duty dual upright spring system
- Mast- 2 stage telescoping: 1-1/2" sq. and 1-1/4" sq. aluminum tubing with .100 wall thickness
- Legs- 1-1/4" sq. x .100 wall x 84" aluminum tube with kick releases (4)

#### **RUR48 SIGN**

- Panel- Reflective vinyl, 48" x 48"
- Rollup style panel for compact storage
- Crossbrace- 1-1/4" wide fiberglass bars (2)
- Flags- 18" x 18" vinyl with 3/4" dia. wood staff (2)



**DICKE TOOL COMPANY** 1201 Warren Avenue Downers Grove, IL 60515 Tel (630)969-0050 Fax(630)969-3973

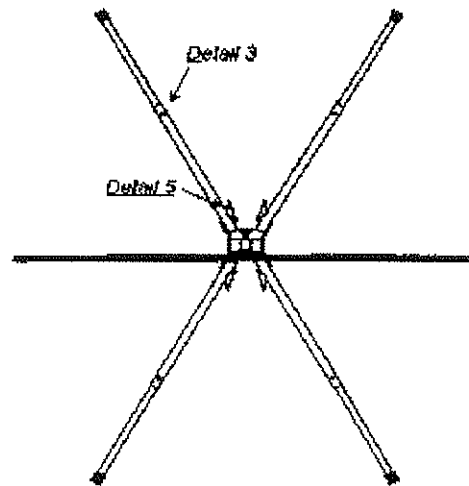
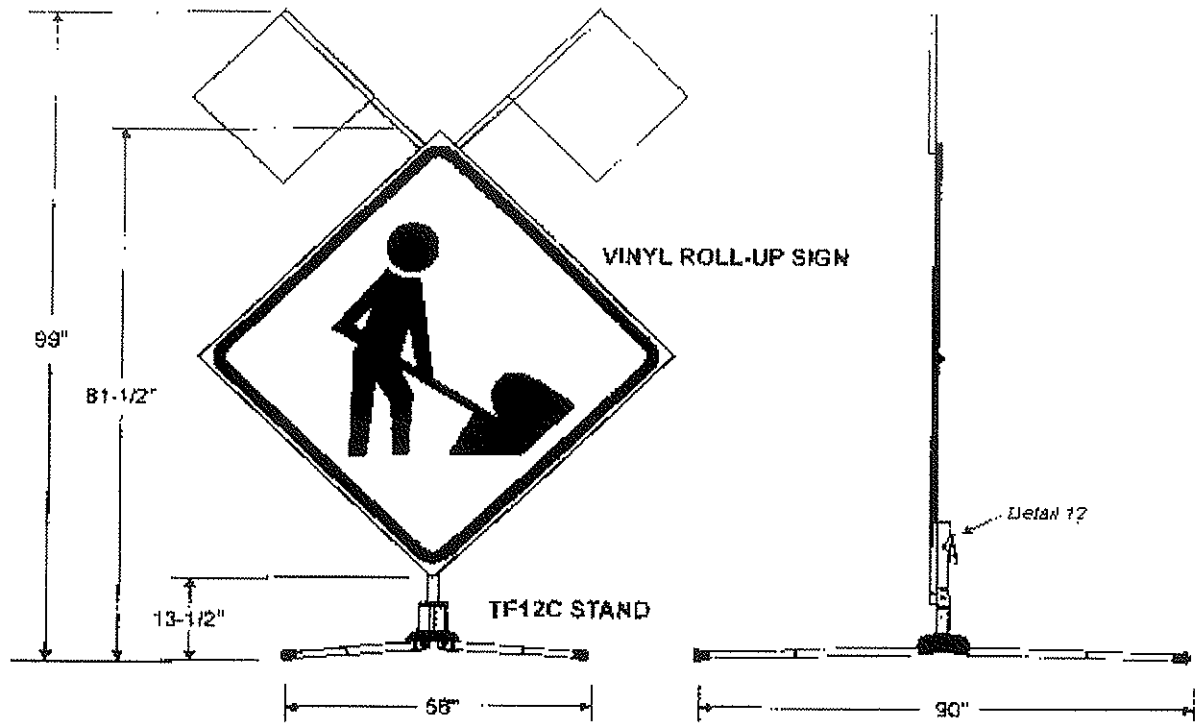

**TF12C STAND**

- Base- Steel with dual upright spring system
- Legs- Telescopic 1-1/4" and 1" sq. aluminum tubing with .100" wall thickness

**RUR44 SIGN**

- Panel- Reflective vinyl, 48" x 48"
- Crossbrace- Vertical member is 3/8" th x 1-1/4" w x 66-1/4" long fiberglass
- Crossbrace- Horizontal member is 3/16" th x 1-1/4" w x 86-1/4" long fiberglass
- Flags- 18" x 18" vinyl with 1/8" th. x 1" w x 30" fiberglass staff



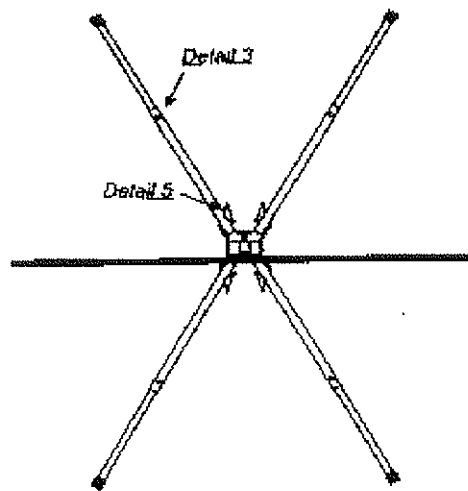
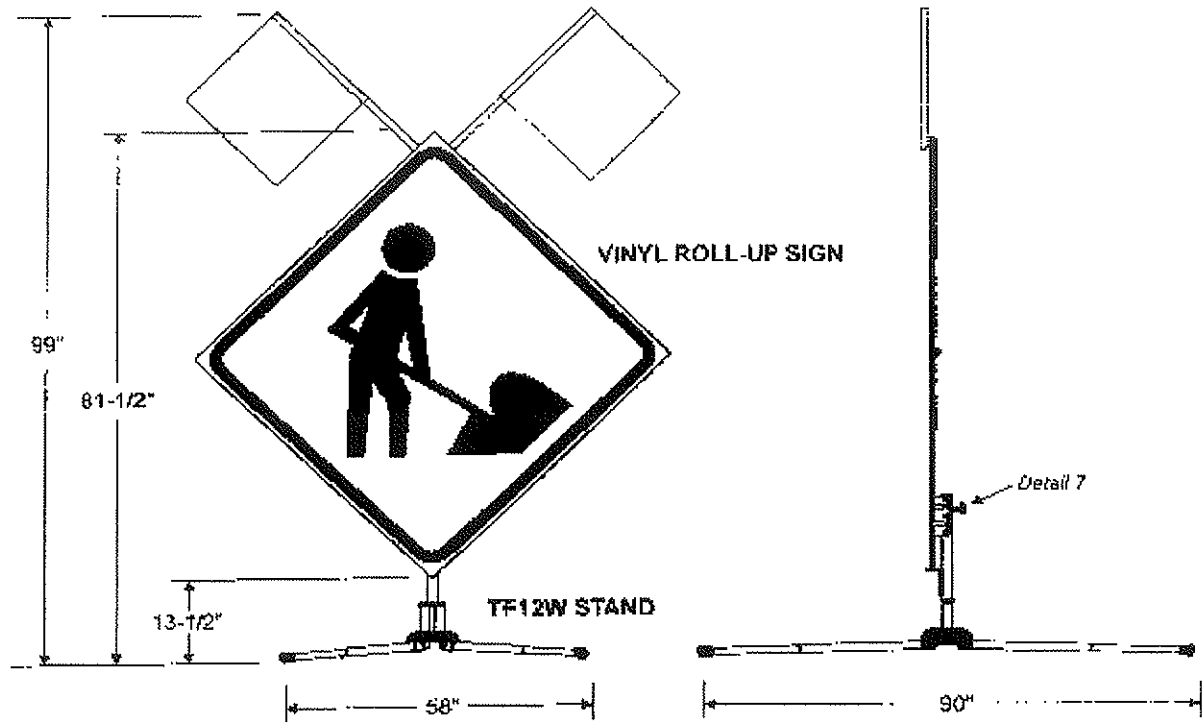

**TF12W STAND**

- ◆ Base- Steel with dual upright spring system
- ◆ Legs- Telescopic 1-1/4" and 1" sq. aluminum tubing with .100" wall thickness

**RUR48 SIGN**

- ◆ Panel- Reflective vinyl, 48" x 48"
- ◆ Crossbrace- Vertical member is 3/8" th. x 1-1/4" w x 66-1/4" long fiberglass
- ◆ Crossbrace- Horizontal member is 3/16" th x 1-1/4" w x 66-1/4" long fiberglass
- ◆ Flags- 18" x 18" vinyl with 1/8" th x 1' w x 30" fiberglass staff



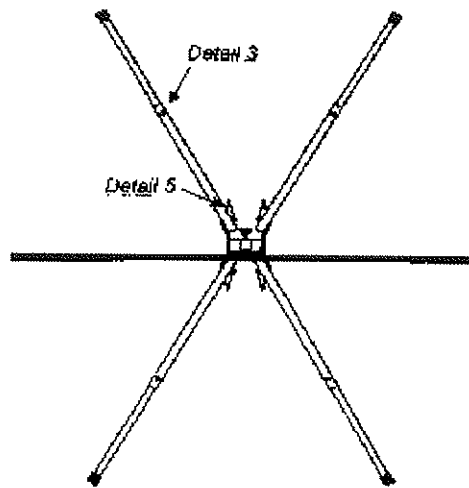
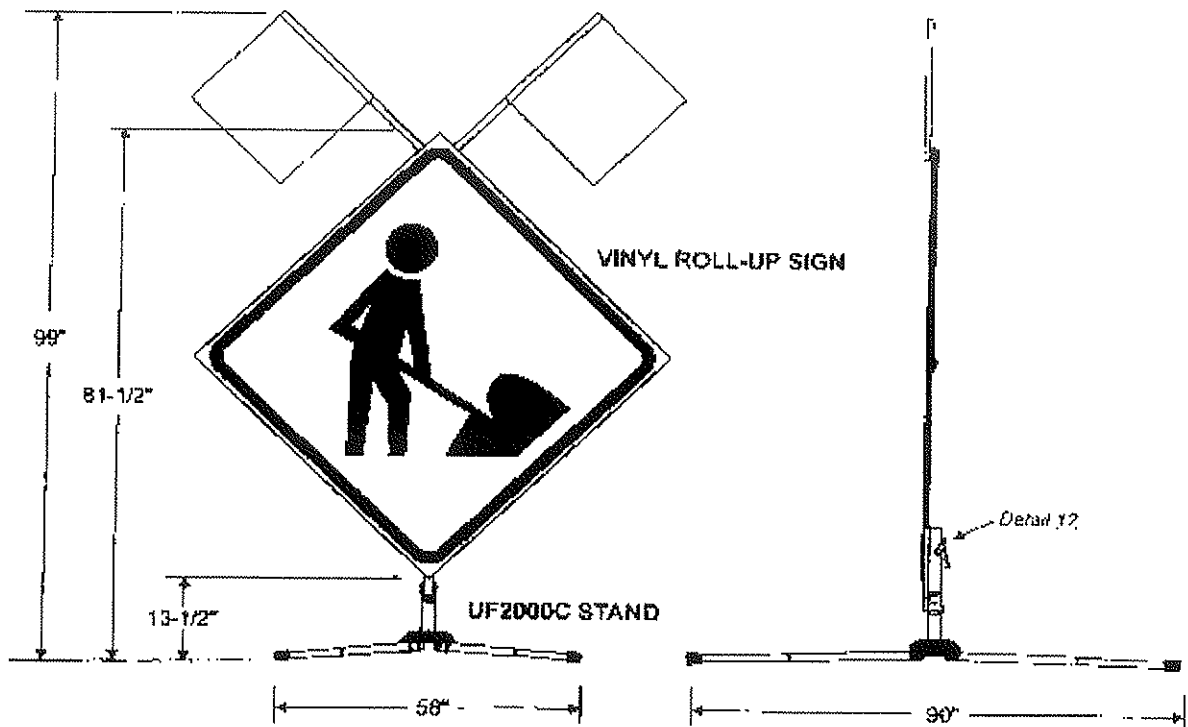

**UF2000C STAND**

- Base- Steel with single upright spring system
- Legs- Telescopic 1-1/4" and 1" sq. aluminum tubing with .100" wall thickness

**RUR48 SIGN**

- Panel- Reflective vinyl, 48" x 48"
- Crossbrace- Vertical member is 3/8" th. x 1-1/4" w x 66-1/4" long fiberglass
- Crossbrace- Horizontal member is 3/16" th. x 1-1/4" w x 66-1/4" long fiberglass
- Flags- 18" x 18" vinyl with 1/8" th. x 1" w x 30" fiberglass staff



**DICKE TOOL COMPANY** 1201 Warren Avenue Downers Grove IL 60515 Tel.(630)969-0050 Fax(630)969-3973

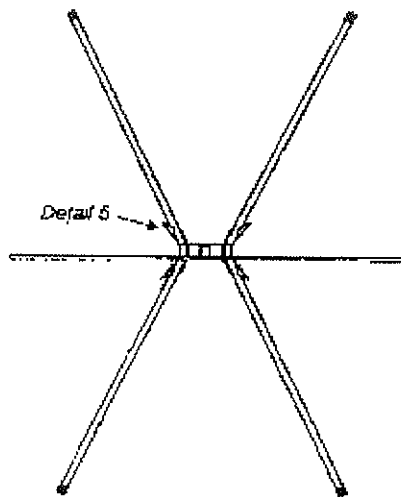
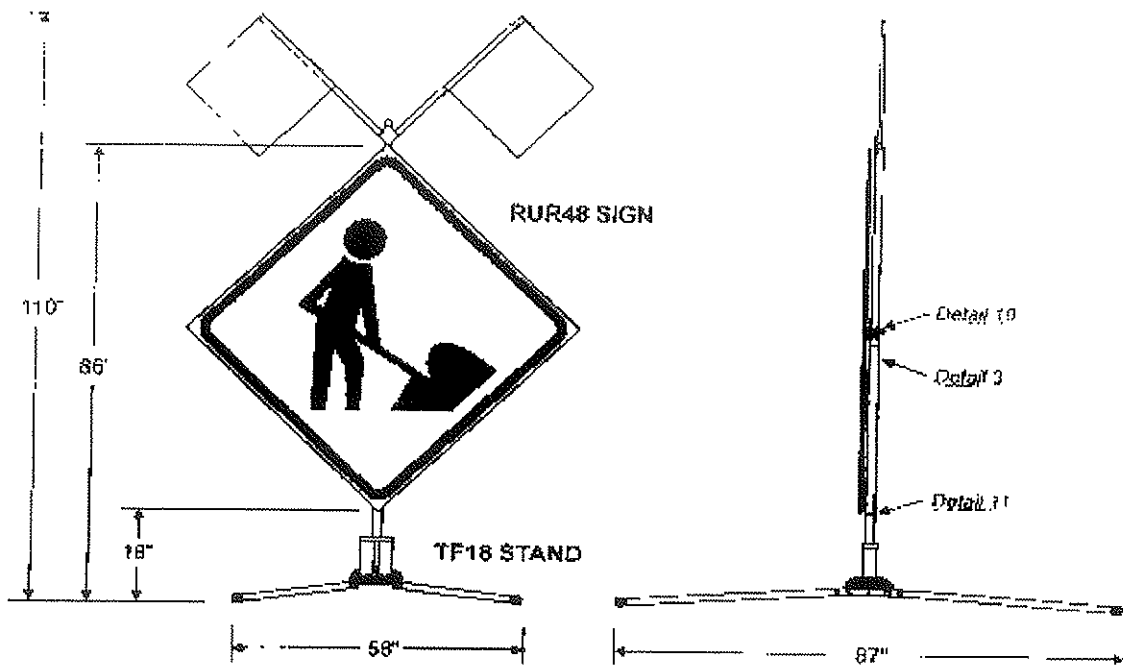

#### **TF18 STAND**

- Base- Steel with heavy duty dual upright spring system
- Mast- 2 stage telescoping, sq. aluminum tubing with .100 wall thickness
- Legs- 1-1/4" sq. x .100 wall x 48" long aluminum legs

#### **RUR48 SIGN**

- Panel- Reflective vinyl. 48" x 48"
- Crossbrace- Vertical member is 3/8" th x 1-1/4" w x 66-1/4" long fiberglass
- Crossbrace- Horizontal member is 3/16" th x 1-1/4" w x 66-1/4" long fiberglass
- Flags- 18" x 18" vinyl with 1/8" th x 1" w x 30" fiberglass staff



**DICKE TOOL COMPANY**

1201 Warren Avenue Downers Grove, IL 60515 Tel. (630) 969-0050 Fax (630) 969-3973

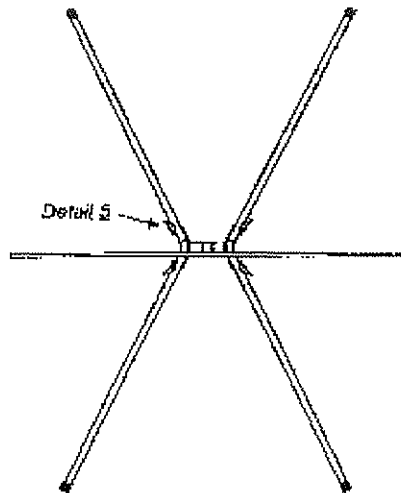
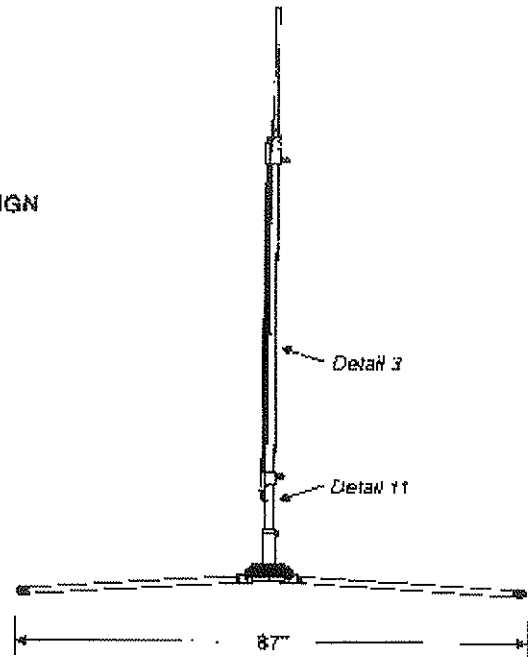
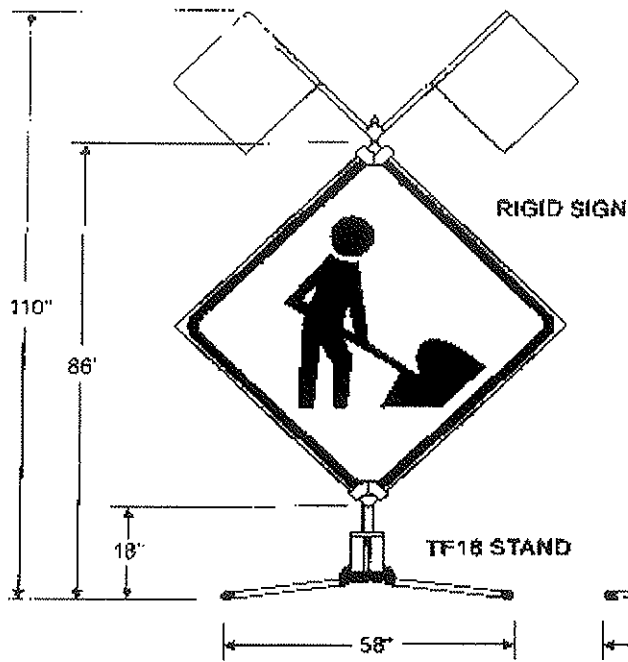

#### **TF18 STAND (Rigid Sign)**

- Base- Steel with heavy duty dual upright spring system
- Mast- 2 stage telescoping, sq. aluminum tubing with .100 wall thickness
- Legs- 1-1/4" sq. x .100 wall x 48" long aluminum legs
- Panel- Rigid .080 -.125 aluminum or 1/2" - 3/4" plywood, 48" x 48".
- Flags- 18" x 18" vinyl with 30" staff
- Weight (without sign panel) - 38 lbs



**DICKE TOOL COMPANY** 1201 Warren Avenue Downers Grove, IL 60515 Tel: (630) 969-0050 Fax: (630) 969-3973